

X-Cite® 120PC Q User Guide

Applies to 120PC Q Series Models:

- XI120PC-Q
- XI120PC-QX

X-Cite® 120PC Q User Guide

035-00328R Rev. 4

Made in Canada

Excelitas Canada Inc. 2018

All rights reserved

No part of this publication may be reproduced, transmitted, transcribed, stored in a retrieval system or translated into any language in any form by any means without the prior written consent of Excelitas Canada Inc.. Every effort has been made to ensure information in this manual is accurate; however, information in this manual is subject to change without notice and does not represent a commitment on the part of the authors.



Excelitas Canada Inc.
2260 Argentia Road
Mississauga ON L5N 6H7 CANADA

Trademarks

X-Cite® 120PC Q and Intelli-Lamp® are registered trademarks of Excelitas Canada Inc.. All other product names are trademarks of their respective owners.

Table of Contents

1	Introduction	1
2	Checking the contents of the box	2
2.1	Box Contents:	2
2.2	Front Panel	3
2.3	Rear Panel	4
3	Safety Information	5
3.1	Glossary of Symbols	5
3.2	Safety Precautions	5
4	Installing the Lamp Module	9
5	Inserting and Removing the Light Guide	13
5.2	Tips to prevent premature degradation of light guides	15
6	Installing the Collimating Adapter	16
7	X-Cite® 120PC Q Message Reference	18
8	Powering Up and Powering Down	19
9	Adjusting the Light Output Intensity	20
10	Timed Exposures	21
10.2	Adjusting the Exposure Time	21
10.3	Running a Timed Exposure	21
11	Additional Functions	22
11.1	Viewing the Accumulated Lamp Hours	22
11.2	Locking/ Unlocking the Up/ Down Adjustment Buttons	22
11.3	Using the Foot Pedal/ Remote Device	23
12	RS-232 Specifications	23
12.1	Introduction	23
12.2	Serial RS-232 Interface	23
12.3	Software Developer's Kit (SDK)	24
12.4	Graphical User Interface	24
13	Graphical User Interface for X-Cite® 120PC Q Control Panel	25
13.1	X-Cite® 120PC Q Software Minimum PC Configuration Requirements	25
13.2	Installing X-Cite® 120PC Q Control Panel Software	25
13.3	X-Cite® 120PC Q Connection	26
13.4	Controlling Unit Functions via the Graphical User Interface	26
14	Messages / Indicators	29
15	Clearing an Audible Alarm	31
16	Troubleshooting	31
16.1	General	31

16.2 Liquid Light Guides.....	33
16.3 Lamps	36
16.4 Air Vents & Filters.....	37
17 Routine Care and Maintenance.....	39
17.1 General tips to help maximize lamp lifetime:.....	40
18 Technical Specifications	41
18.1 Lamp module.....	41
18.2 Light Guide.....	42
18.3 Power Input.....	43
18.4 Lamp Power (electrical).....	43
18.5 Environmental Operating Conditions	43
18.6 Transport and Storage Conditions	43
18.7 Regulatory Compliance	44
18.8 China RoHS	45
19 Warranty	46
20 Contact Information	47
20.1 Service Centers.....	47
20.2 Replacement Parts.....	47

Table of Figures

Figure 1 Front Panel View	3
Figure 2 Rear Panel View.....	4
Figure 3 Lamp Access Panel.....	9
Figure 4 Lamp Housing	10
Figure 5 Lamp Orientation.....	10
Figure 6 Intelli-Lamp Connection.....	11
Figure 7 Lamp Power Connection	12
Figure 8 Lamp Wire Orientation	12
Figure 9 Light Guide Insertion	13
Figure 10 Collimating Adaptor	17

1 Introduction

The X-Cite® 120PC Q represents a new standard in fluorescence illumination. It gives you the convenience and control never before available in a fluorescence illuminator and has been designed to let you focus your energy where it belongs, on obtaining the best possible results.

The heart of the X-Cite® 120PC Q is a proprietary 120-watt short arc lamp with an improved 2000-hour typical lifetime. This extended lifetime is made possible by the proprietary thermal management system incorporated into the design. The lamp is mounted in an elliptical reflector with a proprietary coating to provide unequalled spectral and power output. The new X-Cite® 120PC Q has also been improved for much quieter operation. Standard features incorporated in the X-Cite® 120PC Q include: the pre-aligned Intelli-Lamp® system, an accumulative lamp hour meter and a lamp status indicator.

The X-Cite® 120PC Q joins the Excelitas Technologies family of light systems offering the same high level of innovation, quality and reliability that our commercial customers have come to expect.

Excelitas Technologies Corp. is a global technology leader focused on delivering innovative, customized solutions to meet the lighting, detection and other high-performance technology needs of customers. X-Cite®, formerly of Lumen Dynamics (which was acquired by Excelitas Technologies Corp. in November 2013) offers the Life Science and Analytical Instrumentation market a broad range of innovative lamp and LED fluorescence illumination and measurement solutions.

The X-Cite® 120PC Q is a high quality product manufactured in accordance with ISO 9001, CE marked and certified to UL and CSA standards.

We suggest that you read this manual to discover all features, and how to use them.

Thank you for choosing X-Cite®!

2 Checking the contents of the box

Carefully unpack the unit and accessories. Store the packing material for future use.

2.1 Box Contents:

1. X-Cite® 120PC Q Illumination Unit.....	
2. Lamp Module, X-Cite 120.....	
3. Collimating Adapter.....	
4. Light Guide, X-Cite 120 (3mm x 1.5m or 3mm x 3.0m).....	
5. Power Cord, IEC (grounded).....	
6. Quick Start Guide, X-Cite® 120PC Q (User Guide, Software and Driver downloads: http://www.excelitas.com/Pages/Product/X-Cite-120PC-Q.aspx)	
7. Foot Pedal Switch Assembly.....	
8. Cable Assembly, 9 Pin (RS-232).....	
9. Hex Key, 3mm (lamp access cover).....	
10. Safety Precautions Booklet.....	

If your packaged unit is missing any of the above components, call Excelitas Canada Inc. at (905) 821-2600 or TOLL FREE 1-800-668-8752.

Any additional optional items purchased to customize the unit will also be present.

X-Cite® 120PC Q Control Panel Software

Minimum Computer Specifications:
300+ MHz processor (Pentium or equivalent)
Windows 98, 2000 or XP
32 Mb RAM
20 Mb for Software Installation
20 Mb for Data Storage
SVGA video 800 x 600 resolution
One available RS-232 Port

2.2 Front Panel

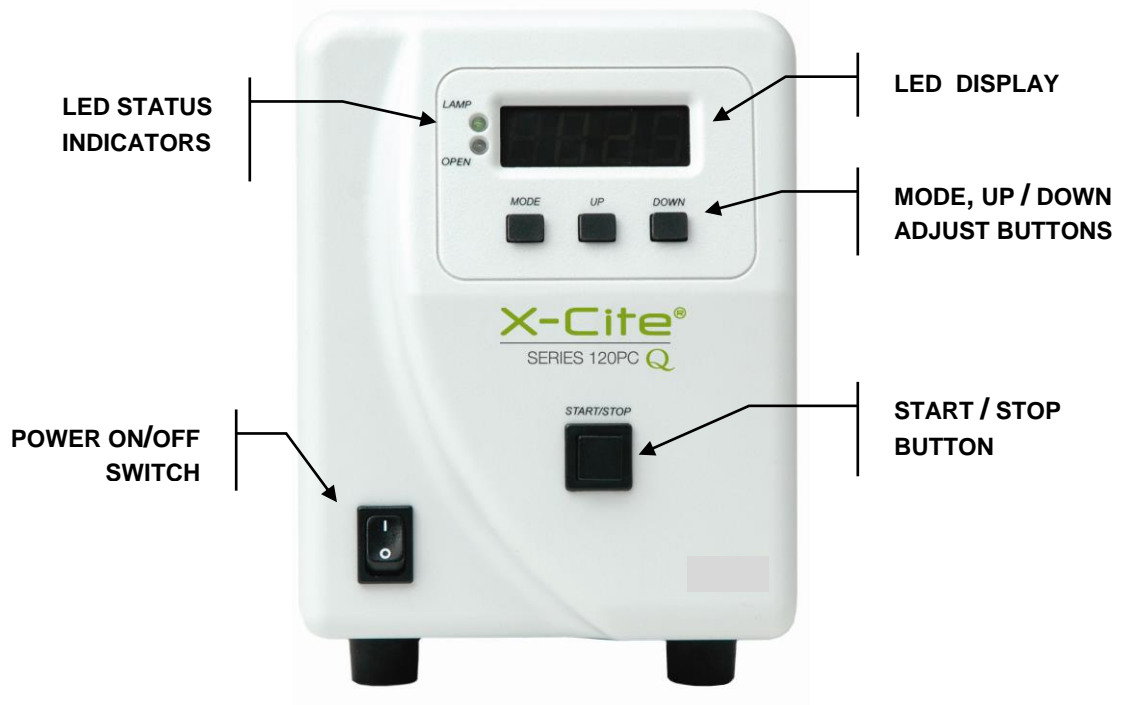

Figure 1 Front Panel View

2.3 Rear Panel

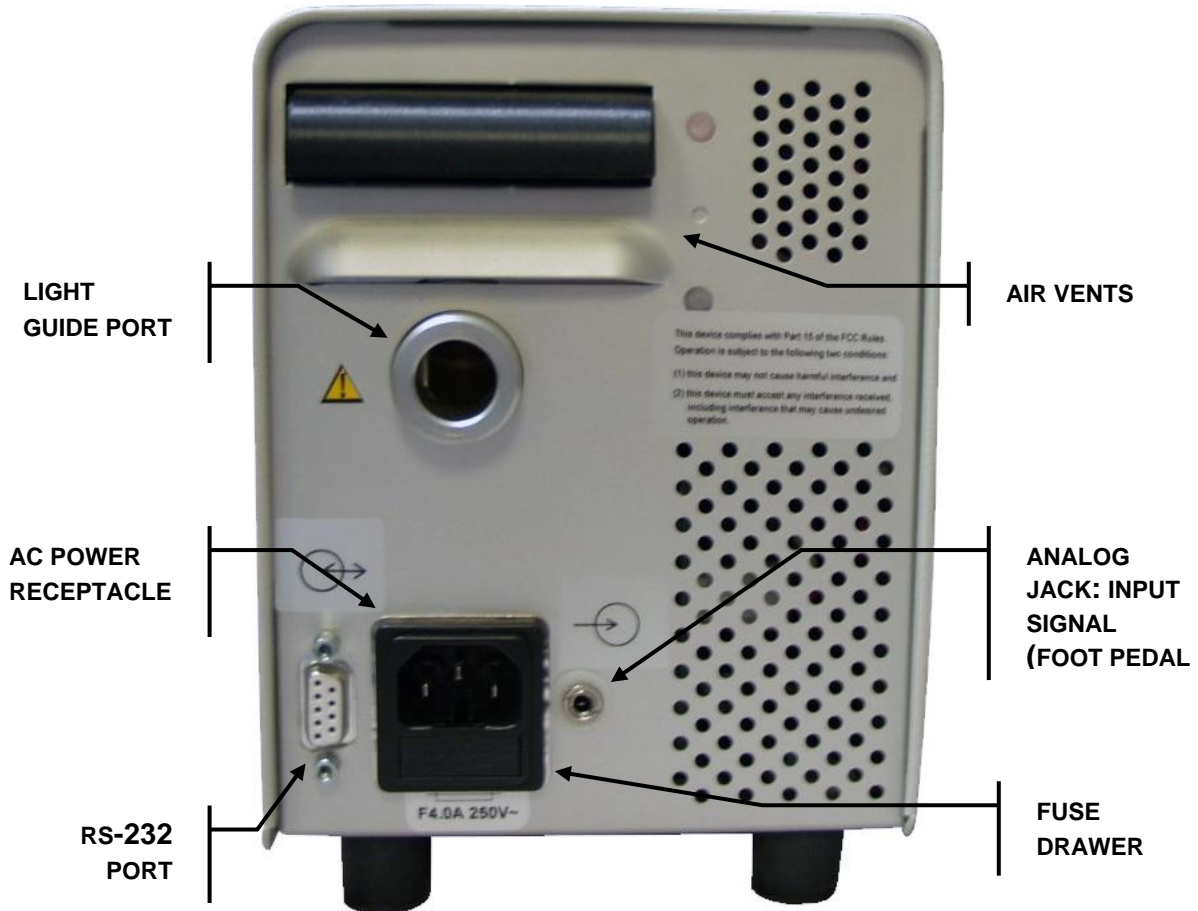

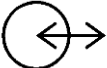
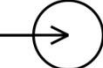



Figure 2 Rear Panel View

3 Safety Information

3.1 Glossary of Symbols

Symbol	Meaning
	CAUTION - Risk of danger: consult accompanying documents
	WARNING – Eye damage may result from directly viewing ultraviolet light. Protective eye shielding and clothing must be used at all times.
	Input/Output Signals
	Input Signal
	CAUTION – Hot surface

3.2 Safety Precautions

The X-Cite® 120PC Q is equipped with two safety sensors to protect the user from accidental UV exposure. In addition, please observe the following precautions during use. This series of cautions, warnings and dangers relate to the operation and maintenance of the X-Cite® 120PC Q. They are also presented throughout this User's Guide where necessary.



Warning

Eye damage may result from directly viewing the light produced by the lamp used in this product. Always use protective eyewear and turn the lamp off before removing cover.



Caution

Never look into the light emitting end of the light guide. The light could severely damage the cornea and retina of the eye if the light is observed directly. Eye shielding must be used at all times as well as clothing to protect exposed skin.



Warning

Always make sure the light guide is properly inserted into the X-Cite® 120PC Q and the microscope prior to turning on power to the unit. This will minimize the risk of exposure to the UV light.



Caution!

To prevent damage/ degradation of the light guide, always allow adequate clearance at the rear of the X-Cite unit to prevent kinking or excessive bending.



Warning

To reduce the risk of fire or shock, always replace the fuses with the same type and rating.

**Warning**

Disconnecting of main supply source is only possible by unplugging the power cord.

**Warning**

This unit is designed for bench top use only! Always ensure that the unit is operated on a hard, stable surface. This will prevent obstruction of the bottom chassis ventilation openings. Any obstruction of these openings could result in a possible over-heating condition. Do not attempt to remove or tamper with the rubber feet located on the bottom of the unit.

**Danger**

This unit contains HIGH VOLTAGE components. It is recommended that ONLY QUALIFIED TECHNICAL PERSONNEL perform any testing or repairs described in this manual. Disconnect the AC power cord from the unit before opening the cover of this unit. All cover screws must be replaced prior to applying power to the unit, or safety of the unit will be impaired.

**Monitoring the unit during manual operation**

The level of UV energy supplied by the X-Cite® 120PC Q is sufficient to ignite flammable substances. During manual operation, the unit must be attended at all times by a qualified operator. The unit must not be left unattended while turned on. If an operator leaves the work area of the unit, the lamp power switch must be turned off.

**Monitoring the unit during Automated operation**

The level of UV energy supplied by the X-Cite® 120PC Q is sufficient to ignite flammable substances. Therefore, when the unit is operated unattended in an automated environment, an alarm function must be provided by the user to indicate a malfunction in the associated equipment used.

**Warning**

Hg – LAMP CONTAINS MERCURY, Manage in Accord with Disposal Laws, see: www.lamprecycle.org or 1-800-668-8752

Danger: Exposure to Mercury represents a health hazard to humans.

When unpacking or installing the lamp, always wear protective clothing and a face mask. Operate lamp only in the X-Cite 120 lamp housing. This prevents direct viewing of the arc and in the case of lamp bursting, contains the lamp particles. In the rare instance in which a lamp bursting occurs, and the mercury content is released, the following safety precautions are recommended: all personnel should be immediately evacuated from the area to prevent inhalation of the mercury vapour. The area should be well ventilated for a minimum of 30 minutes. Prior to clean up ensure an approved mercury respirator mask and non-porous gloves such as latex or rubber are used. After the lamp housing elements have cooled, the mercury residue should be collected with the use of a special absorbing agent available from laboratory equipment suppliers.

**Warning**

Should this X-Cite® 120PC Q unit be used in a manner not specified by Excelitas Technologies, the protection provided by the equipment may be impaired.

**Warning**

The method in which lamps are disposed of must comply with local rules & regulations for disposal of hazardous materials. Lamps may be returned to Excelitas Technologies providing they are returned in their original packaging. Excelitas Technologies will dispose of them in the appropriate manner.

**Caution**

The lamp module's operational life can be significantly shortened if it is handled incorrectly. Do not touch the bulb's glass envelope or the inside surface of the reflector. Skin oils can cause the lamp module to fail prematurely.

**Caution**

Prior to opening the unit and handling the lamp module, allow the lamp module to cool down completely.

**Caution**

Any electronic equipment connected to the X-Cite® 120PC Q must be IEC950 certified.

**Cleaning:**

Clean exterior of the unit with a water dampened cloth and simple detergent only.

4 Installing the Lamp Module



Note: Refer to Section 3 – Safety Precautions before proceeding

- 4.1.1 Be sure the AC power cord is disconnected from the unit.
- 4.1.2 Remove the screw from the top of the lamp access panel using the 3mm hex key provided and remove the panel.

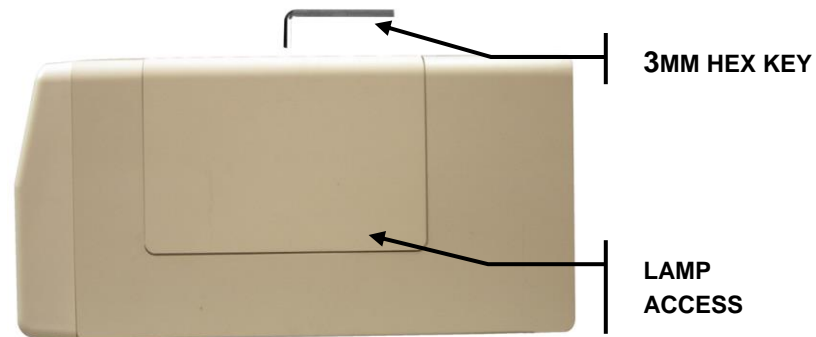

Figure 3 Lamp Access Panel

- 4.1.3 Carefully remove the lamp module from its container, holding only the ceramic components.



Caution!

The lamp module's operational life can be significantly shortened if handled incorrectly. Be sure only to handle the ceramic surfaces. Do not touch the bulb's glass envelope or the inside surface of the reflector. Skin oils can cause the lamp module to fail prematurely.

4.1.4 Open the lamp bracket arm by pulling towards you, refer to Figure 4

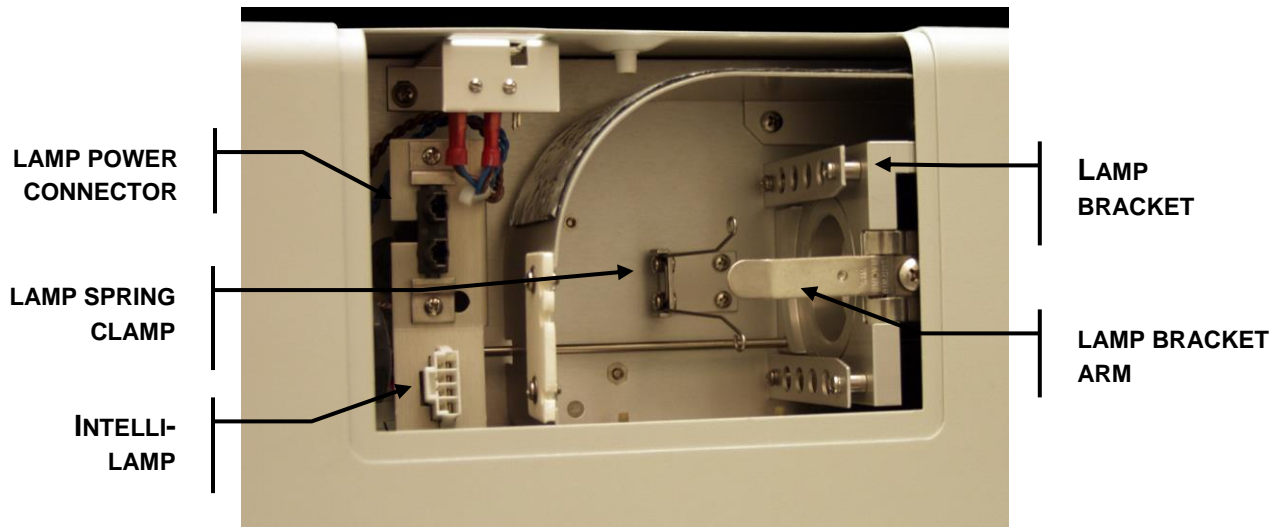

Figure 4 Lamp Housing

4.1.5 Position the lamp so that the two leading edges of the lamp ceramic mount slide into the groove of the lamp bracket. The middle of the lamp should be in position to fit into the spring clamp. Reference Figure 5

Tip: Make sure that the “This side out” label is facing outwards before trying to insert the lamp as illustrated below. Reference Figure 5

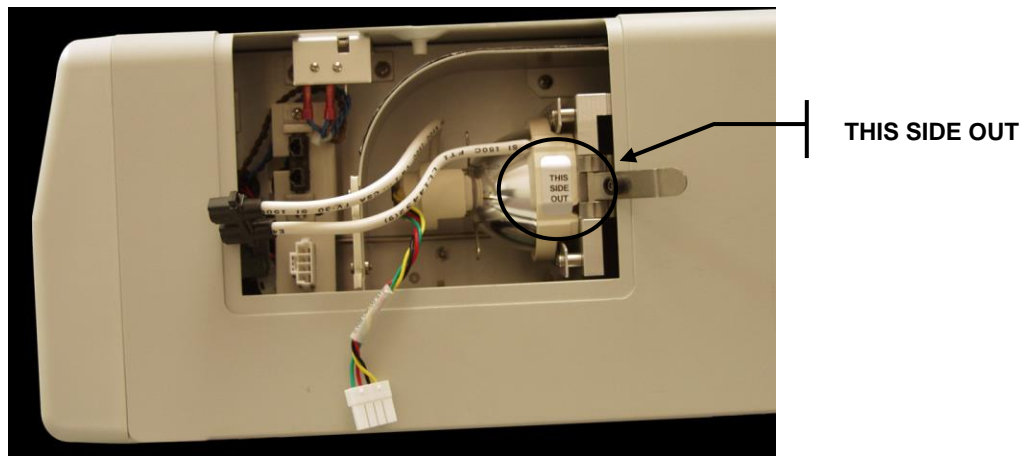

Figure 5 Lamp Orientation

- 4.1.6 Slide the lamp all the way in so that both leading edges of the lamp ceramic mount are in the groove of the lamp bracket. The middle of the lamp will snap into the spring clamp. Close the lamp bracket arm. Reference Figure 5
- 4.1.7 Locate the 4-pin Intelli-Lamp sensor connector (multi-coloured wiring harness) at the rear of the lamp module and connect it to its mate located on the lamp-housing wall. Reference Figure 6.

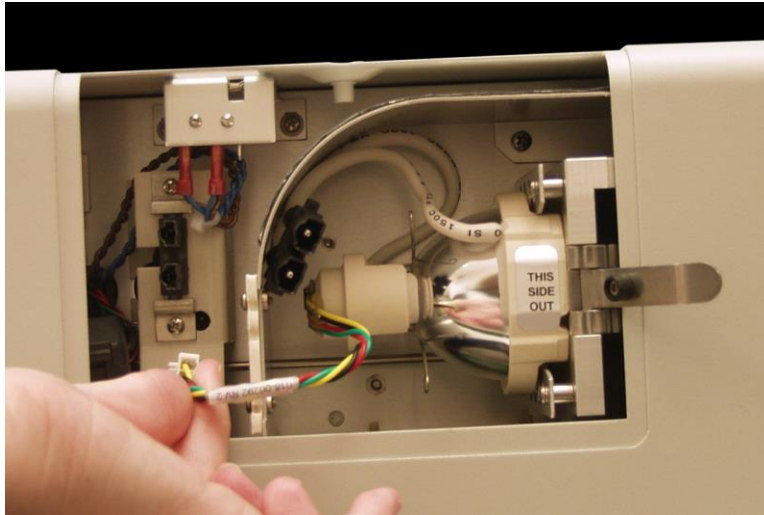

Figure 6 Intelli-Lamp Connection

Tip: *The Intelli-lamp connector will only attach in the correct orientation. If you are having difficulty attaching the connector, try rotating it by 180°*

- 4.1.8 Attach the 2-pin lamp power connector to its mate on the lamp-housing wall. Reference Figure 7



Figure 7 Lamp Power Connection

Tip: The 2-pin lamp power connector will only attach in the correct orientation. If you are having difficulty attaching the connector, try rotating it by 180°

- 4.1.9 Ensure the Intelli-Lamp sensor and the lamp power leads are secured into the appropriate alignment grooves of the lamp housing. Reference Figure 8.

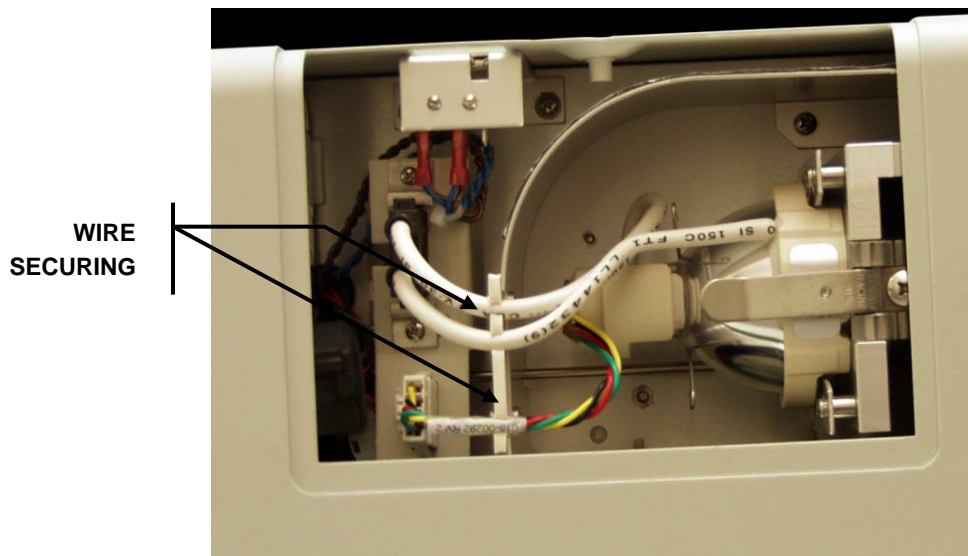

Figure 8 Lamp Wire Orientation

- 4.1.10 Replace the lamp access panel and tighten the fastening screw. Reference Figure 3.

Note: *If the lamp module has been installed incorrectly the message "bulb" will appear on the display and a continuous audible beep will be heard after the 90 second warm-up cycle has been completed.*



Warning

This unit is designed for bench top use only! Always ensure that the unit is operated on a hard, stable surface. This will prevent obstruction of the bottom chassis ventilation openings. Any obstruction of these openings could result in a possible over-heating condition. Do not attempt to remove or tamper with the rubber feet located on the bottom of the unit.

5 Inserting and Removing the Light Guide

- 5.1.1 Make sure that power is off to the X-Cite® 120PC Q unit.
- 5.1.2 Ensure that the protective end caps are removed from both the input and output ends of the light guide prior to installation.
- 5.1.3 Insert the light guide into the light guide retainer located on the back panel of the unit. Push the light guide in until it seats with a second positive "click" (up to the "A" line printed on the grey ferrule). Reference Figure 9.



Figure 9 Light Guide Insertion

Tip: When the light guide is fully inserted, the line on the light guide insertion label will be right up against the light guide port.

Note: If the light guide is not inserted properly, it may result in reduced light output and overheating which can cause premature degradation of the light guide.

- 5.1.4 During installation or removal, grasp the light guide on the strain-relief nearest the input end of the light guide. Reference Figure 9.

Note: Never grip the light guide during installation or removal by any other part other than the strain relief portion

- 5.1.5 To remove the light guide, firmly grip the strain relief near the light guide retainer and pull out firmly.

Note: The X-Cite 120 PC is designed for use with a 3mm liquid light guide. Excelitas Technologies can not guarantee the performance of the X-Cite 120 PC if using light guides other than those supplied by Excelitas Technologies.

5.2 Tips to prevent premature degradation of light guides

Refer to [section 16](#) for detailed set-up and maintenance tips.

- 5.2.1 Liquid light guides have a typical useful life of 2-3 years in the X-Cite® 120PC Q when installed and handled properly. The formation of bubbles is one of the most common reasons for a light guide to degrade prematurely and result in a sudden reduction in illumination intensity. Bubbles form without warning, usually due to overheating and/or mechanical stress to the light guide. Below are some simple tips to avoid overheating and stressing the light guide.
- 5.2.2 The light guide has a minimum bend radius of 1.6 inches (40.0mm). Bending or coiling the light guide tighter than this radius will result in permanent damage to the light guide.
- 5.2.3 Make sure the light guide is cooled properly during use, and prevent overheating:
 - a. Always fully insert the light guide in to the X-Cite unit; this ensures contact with a heat sink to conduct heat away from the light guide.
 - b. Never obstruct the air vents on the X-Cite unit. Vents are located at the rear and underside of the unit. (Note: In earlier X-Cite models vents were located on the side, underneath the lamp access panel.)
 - c. Do not remove the rubber feet on the X-Cite unit or otherwise reduce/block the space between the bottom of the unit and bench top. This may compromise airflow through the unit.
 - d. Ensure that the air being used to ventilate the X-Cite unit is approximately “room temperature” (e.g. do not place the X-Cite unit on top of another heat-producing instrument).
 - e. If a heated environmental chamber is being used for live cell imaging, make sure that the X-Cite unit and the light guide are located outside of the chamber.
- 5.2.4 Do not expose the light guide to extreme temperatures (above 35°C, below -5°C) for extended periods of time during use, transport or storage; this may cause degradation of the seals and allow air bubbles to form in the liquid.
- 5.2.5 Never kink, bend, crush, or stretch the light guide; this type of mechanical stress may cause bubbles to form in the liquid and/or damage to the outer sheath
 - a. Always allow adequate clearance at the rear of the X-Cite unit to prevent excessive bending
 - b. Place the X-Cite unit close enough to the microscope so that there is some slack in the light guide and no sharp bends.

- 5.2.6 Never leave an endcap on the output end of the light guide when the other end is connected to the X-Cite unit; if the unit is turned on in this condition, the cap will overheat, melt and/or permanently discolour the quartz end of the light guide.
- 5.2.7 While the X-Cite unit is on but not in actual use (i.e. during sample preparation, or between time-lapse time-points) close the iris/shutter on the X-Cite; this reduces unnecessary UV photon load on the liquid light guide. (Using only the shutter/stop in the microscope itself protects the specimen, but energy is still passing through the light guide.

6 Installing the Collimating Adapter

- 6.1.1 Ensure that the power is off on the X-Cite® 120PC Q unit.
- 6.1.2 The existing lamp housing must be removed from the microscope before the collimating adapter can be mounted. Do not discard the existing mounting hardware, since it will be used to secure the collimating adapter to the microscope.
- 6.1.3 Remove the collimating adapter from its packaging.

Note: The collimating adapter has been set at the factory. No adjustments by the customer are required.

- 6.1.4 Insert the flange portion of the collimating adapter into the lamp port of the microscope. Using the existing hardware, tighten the screw(s) until the flange is fully secured.

Note: *The installation of the collimating adapter will vary with microscope models.*

- 6.1.5 Remove the protective cap from the output end of the light guide. Insert the light guide into the input portion of the collimating adapter until it is flush with the adjustable insert. Secure the light guide to the collimating adapter by tightening the thumbscrew. Do not over tighten.

Note: *The light guide has a minimum bend radius of 1.6 inches (40.0mm). Bending or coiling the light guide tighter than this radius will result in permanent damage to the light guide.*

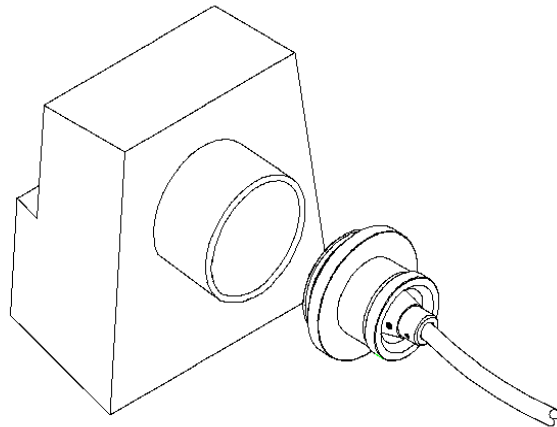

Figure 10 Collimating Adaptor



Warning!

Turning power on to the X-Cite 120 PC unit without the light guide properly installed in the unit and in the microscope can increase your risk of exposure to UV light.

7 X-Cite® 120PC Q Message Reference

Symbol	Message	Description
XXXX.	Lamp Hours	Displays the accumulated hours the lamp has been on
XXX.X	Exposure Time	Displays the time in seconds the shutter will remain open when activated.
XXX	Iris Setting	Displays the iris setting in a percentage of maximum.
Flashing "XXX.X"	Flashing display	The lamp is warming up. Warm up time is approximately 90 sec.
bulb	Bulb Error	Lamp installed incorrectly / Lamp did not strike or extinguished after striking
cool	Cool Warning	Lamp is too hot to strike. The lamp will automatically strike when it has reached optimum striking temperature
old / bulb	Alternating Old and then Bulb	The lamp has accumulated over 2500 hours. Lamp may be near end of life.
end / bulb	Alternating End and then Bulb	The lamp has accumulated over 4000 hours. The lamp will not strike.
LOC	Adjustment Locked	The UP/DOWN adjustment buttons have been locked. No changes can be made to the exposure time or iris setting.
ULOC	Adjustment Unlocked	The UP/DOWN adjustment buttons have been unlocked. Changes can be made to the exposure time and iris setting
SFI	Shutter Failure	The shutter has failed. Unit should be restarted. If the error repeats unit should be serviced.

See Section 16 for troubleshooting.

8 Powering Up and Powering Down

Lamp Warm-Up:

The ARC lamp has 3 distinct phases of operation;

- 1. Ignition.*
- 2. Warm-up. Excelitas Technologies recommends 20 minutes of proper warm-up and to ensure a stable optical output.*
- 3. Stable Operation.*

*It is recommended that phase 1 and 2 are not interrupted. This can result in shortened lamp life. **The lamp must be allowed to warm-up uninterrupted.***

- 8.1.1 Ensure that the lamp and light guide have been properly installed and that the lamp access cover is securely fastened.
- 8.1.2 Plug the X-Cite® 120PC Q unit into a properly grounded AC outlet.
- 8.1.3 Set the main power switch (I / O), located on the front panel to the “I” ON position and check the fan for airflow.
- 8.1.4 The lamp will automatically turn on within 20 seconds and the lamp indicator LED on the front panel will illuminate. The display will flash for the warm-up period of 90 seconds. The display will stop flashing when the warm-up cycle has been completed. Wait until the warm up cycle has been completed before using the X-Cite® 120PC Q to perform an exposure. Excelitas Technologies recommends 20 minutes to ensure a stable output.

Note: *Unit should not be turned off unless the lamp has been on for a minimum of twenty minutes.*

Note: *If the lamp is turned off, and an attempt is made to turn it back on before it has fully cooled, the “cool” message will appear on the display. The lamp will automatically re-strike when the lamp has cooled.*

- 8.1.5 To power down the unit, set the mains power switch (I / O), to the “O” OFF position.

9 Adjusting the Light Output Intensity

- 9.1.1 Your X-Cite® 120PC Q system includes an iris adjustment to control the amount of light output from the unit. Adjustments to the output can only be made when the X-Cite® 120PC Q unit is in Intensity Mode.

Note: *When the unit is connected to a PC or the front panel has been manually locked, exposure settings can not be adjusted from the X-Cite 120 PC front panel buttons.*

- 9.1.2 Set your X-Cite® 120PC Q to Intensity Mode by pressing the Mode button until the LED display shows 3 digits “XXX”. The three digit number shown will indicate the iris setting as a percentage of maximum.



Warning:

UV light and high levels of visible light will be emitted from the light guide. Opening the shutter on the X-Cite 120 PC without the light guide properly installed in the unit and in the microscope can increase your risk of exposure to UV light.

- 9.1.3 Press the START /STOP button to manually open the shutter. The open LED indicator on the front panel will illuminate.
- 9.1.4 Press the up button to increase the light output or press the down button to decrease the light output. The percentage of the iris opening displayed will increase or decrease to 0%, 12%, 25%, 50% or 100% each time the up or down button is pressed.

Note: *No light will be emitted from the unit when the iris opening is set to 0% or if the START /STOP button has not been pressed to activate the shutter.*

- 9.1.5 Press the start /stop button to manually close the shutter. The open indicator LED will turn off once the shutter has closed.

Note: *While in Intensity Mode, pressing the START/STOP button will manually open the shutter. The shutter will remain open until the START/STOP button is pressed once again to close the shutter. Use this mode to override the timer function if manual operation of the shutter is required.*

10 Timed Exposures

- 10.1.1 Your X-Cite® 120PC Q system includes a timer to automatically close the shutter after a user selected amount of time. Adjustments to the exposure time can only be made when the X-Cite® 120PC Q unit is in Timer Mode and the shutter is closed.

Note: *When the unit is connected to a PC or the front panel has been manually locked, exposure settings can not be adjusted from the X-Cite 120 PC front panel buttons.*

10.2 Adjusting the Exposure Time

- 10.2.1 Set your X-Cite® 120PC Q to Timer Mode by pressing the Mode button until the four digits are displayed as “XXX.X” The number shown will indicate the exposure time in seconds and tenths of a second.
- 10.2.2 Press the up button to increase the exposure time by 1/10 sec, or press the down button to decrease the exposure time by 1/10 sec.

Note: *The minimum available exposure time is 0.2 seconds*

- 10.2.3 For coarse adjustments, press and hold the up or down button to rapidly increase or decrease the exposure time.

10.3 Running a Timed Exposure

- 10.3.1 Ensure that your X-Cite® 120PC Q unit is set to timer mode or lamp hour mode as per section 11.1.
- 10.3.2 Press the START /STOP button. The shutter will automatically open and the exposure time will begin to count down. When the exposure time has elapsed to zero, the shutter will automatically close and the timer mode will automatically reset to the preset value.

Note: *The OPEN LED indicator will illuminate when the shutter is open*

- 10.3.3 If the X-Cite® 120PC Q is in timer mode, and a timed exposure is activated, the display will show the remaining time while the shutter is open.
- 10.3.4 To stop a timed exposure during an exposure cycle, press the START /STOP button. The shutter will immediately close and the exposure time will automatically reset. The open indicator will turn off.

11 Additional Functions

11.1 Viewing the Accumulated Lamp Hours

- 11.1.1 Your X-Cite® 120PC Q system automatically accumulates the number of hours that the lamp is on and shows this information on the LED display. The lamp hours are shown when the unit is in Lamp Hour mode.
- 11.1.2 Set your X-Cite® 120PC Q to Lamp Hour Mode by pressing the Mode button until the four digits are displayed as “XXXX.” (a flashing decimal point to the right). This shows the number of accumulated hours on the lamp.

Note: Pressing the START/STOP button while in Lamp Hour mode will open the shutter for the pre-set Exposure Time (see Section 10).

11.2 Locking/ Unlocking the Up/ Down Adjustment Buttons

- 11.2.1 Your X-Cite® 120PC Q system allows you to lock or disable the Up/ Down buttons located on the front display panel. When the system lock has been engaged, no adjustments to the exposure time or iris opening can be made. This can help to ensure constant exposures when the X-Cite® 120PC Q is utilized by multiple operators.

- 11.2.2 To Lock the Up/ Down push buttons:

- 1) Push and hold the Mode button
- 2) While pressing the Mode button, press the following sequence of buttons:

DOWN - UP - UP - UP

- 3) After 2 seconds the message “**LOC**” will momentarily appear for 2 seconds then vanish.

- 11.2.3 To Unlock the Up/ Down push buttons:

- 1) Push and hold the Mode button
- 2) While pressing the Mode button, press the following sequence of buttons:

DOWN - UP - UP - UP

- 3) After 2 seconds the message “**ULOC**” will momentarily appear for 2 seconds then vanish.

11.2.4 Once the system is unlocked, all of the front panel buttons will perform as per their normal function.

11.3 Using the Foot Pedal/ Remote Device

11.3.1 To use a foot pedal or other remote control device to control the shutter on your X-Cite® 120PC Q system, insert a 3.5mm audio style plug into the jack located on the rear panel.

Note: Any connections to the remote jack must use a shielded cable

11.3.2 Depressing the foot pedal, or providing a momentary contact closure, will provide the same function as pressing the START/ STOP button. The shutter will open as per the current mode setting of the unit.

11.3.3 The foot pedal connector, a 3.5mm audio style jack, has the following pin-out connections:

Connection Point:	Signal Name:
Outer rim	Common (GND)
Center pin	Positive input, active low

12 RS-232 Specifications

12.1 Introduction

12.1.1 The X-Cite® 120PC Q software is designed to provide remote control of the microscope illumination system from a PC.

12.1.2 The X-Cite® 120PC Q software requirement specification detailed below describes the communication protocol between the X-Cite® 120PC Q unit and the PC.

12.2 Serial RS-232 Interface

12.2.1 The RS-232 serial interface is used to allow data to be transferred to and from a PC to perform a variety of functions, all of which are initiated by a program that executes on the PC.

12.3 Software Developer's Kit (SDK)

The command list for X-Cite® 120PC Q is available by request. To obtain the latest update, please contact Excelitas Technologies.

12.4 Graphical User Interface

12.4.1 When the X-Cite® 120PC Q is connected to a PC, the unit front panel will be automatically locked. The unit status will be sampled at twice per second.

12.4.2 The following screen shot is the GUI application window which will appear on the user's PC.

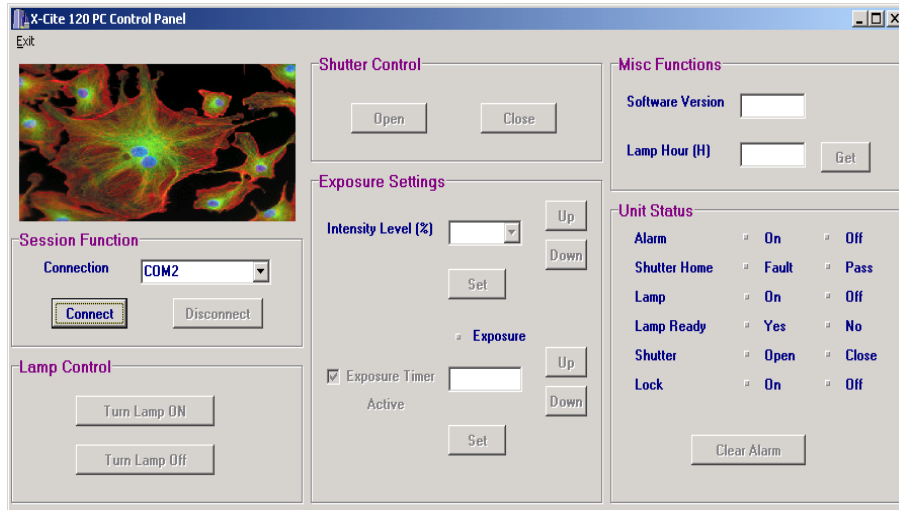

Note: For detailed GUI operating instructions refer to Section 13.

13 Graphical User Interface for X-Cite® 120PC Q Control Panel

The purpose of the GUI (Graphical User Interface) is to provide control of the X-Cite® 120PC Q functions via a remote PC.

13.1 X-Cite® 120PC Q Software Minimum PC Configuration Requirements

13.1.1 The following are the minimum requirements for a PC to be used with the X-Cite® 120PC Q Control Panel software:

- Available RS-232 COM port required for one-time setup procedure and for remote unit operation, a USB to RS-232 adapter can be used.

13.1.2 Operating System Requirements:

- Microsoft Windows® XP, Vista, 7 or 8 32 or 64 bit OS's.

13.2 Installing X-Cite® 120PC Q Control Panel Software

13.2.1 Perform the following to install the X-Cite® 120PC Q software:

- 1) Turn on the PC to be used with the X-Cite® 120PC Q system
- 2) Shut down any other Windows programs currently in use
- 3) Download the X-Cite® 120PC Q Control Panel software from our website:
<http://www.excelitas.com/Pages/Product/X-Cite-120PC-Q.aspx>
- 4) In your downloads folder, search for and open the "X-Cite_120PC_GUIr2.zip" file.
- 5) Double click on SETUP.EXE
- 6) Next follow the setup instructions as they appear by clicking "next" each time the user prompt appears, until the installation has been completed and "finish" appears. Click on "finish" to complete the installation.
- 7) To access the control panel software program, click on the Windows Start menu and select: programs/ X-Cite® 120PC Q Control Panel ► / X-Cite® 120PC Q Control Panel. A screen with a title bar displaying "X-Cite 120 Control Panel" will appear on your monitor. Refer to Section 17.5 for sample screen shot of the X-Cite® 120PC Q application window.

13.3 X-Cite® 120PC Q Connection

- 13.3.1 Connect the rear panel RS-232 port on the X-Cite® 120PC Q unit to an available COM port on your PC using the 9 pin cable assembly supplied.
- 13.3.2 Ensure that your X-Cite® 120PC Q unit is plugged in a functional AC outlet.
- 13.3.3 Turn on the front panel power switch and wait until the 90 second warm-up period has been completed (front display has stopped flashing).
- 13.3.4 Next, on the GUI, in the “Session Function” control block, click your mouse on the “Connection” list box to select the appropriate COM port link. Select “COM 1” or “COM 2”, etc.
- 13.3.5 Next, click on the “Connect” button. If the wrong COM Port number has been selected, then the following error message will appear:

“No response from unit”. If this occurs click on “Cancel” and re-select the appropriate COM port.

Note: *Once the appropriate link has been established all the functional buttons on the graphical user interface will become enabled (high-lighted). Disabled (non-functional) control buttons are greyed out.*

13.4 Controlling Unit Functions via the Graphical User Interface

- 13.4.1 Once a COM link has been established between the X-Cite® 120PC Q unit and the user’s PC, the front panel controls and rear panel analog jack controls become disabled. The display will indicate elapsed lamp hours only. The Unit Status indicator on the GUI will indicate Lock “On”.

13.4.2 Lamp On/ Off Control

1. The lamp in the X-Cite® 120PC Q is turned on automatically once the front panel power switch on the unit is set to the ON position.
2. To remotely turn the lamp off, click on the “Turn Lamp Off” button in the *Lamp Control* section on the GUI. The following message will be displayed: “Are you sure you want to turn the lamp off?” Click on “Yes” to confirm. The lamp will shut off and the *Unit Status* indicators will confirm by showing *Lamp “Off”* and *Lamp Ready “No”*. To turn the lamp back on, click on the “Turn Lamp On” button.

Note: *During the lamp warm-up cycle, or if the lamp is too hot to strike, both “Lamp On” and “Lamp Off” buttons will be disabled until the warm-up/cooling cycle has been completed. Once the “Turn Lamp On” button has been selected, the lamp will turn on automatically when the unit has cooled to the appropriate temperature.*

13.4.3 Exposure Settings: Intensity Level

Intensity level can be selected by the following 2 different methods:

Method 1: Click on the “Up/ Down” buttons located right of “Intensity Level (%)” to select the desired level (0, 12, 25, 50 or 100).

Method 2: Click on the arrow of the “Intensity Level (%)” list box. Once the desired value has been selected, click on the “Set” button to enter the value. Once the “Set” button becomes disabled, the intensity level has been entered.

Note: *If 0% is selected the shutter will not open and the error message will appear: “Intensity level is 0, shutter will not open”. If this occurs click on “Cancel” and reset the intensity level at 12% or greater.*

13.4.4 Exposure Settings: Exposure Timer

Ensure that the check box next to “Exposure Timer Active” has been *selected*. Exposure time can be selected by the following 2 different methods:

Method 1: Select exposure time by clicking on the “Up/ Down” buttons located right of the “Exposure Timer”. The exposure time will change in increments of 1 second. If a value outside of acceptable limits is chosen, the error message: “Value is outside allowable range” will appear. Select “Cancel” and re-enter a value within the allowable range.

Note: *If another value is not selected, the X-Cite® 120PC Q will automatically retain the value that was previously selected prior to the error message being displayed.*

Method 2: Click with your mouse on the “Exposure Timer” list box and type in the desired value. Click on the Set button, once the button is disabled the selected value has been entered. The allowable exposure range by this method is 0.2 to 999.9 seconds. If a value outside the range is entered, an error message “Value is outside allowable range” will appear. Select “Cancel” and re-enter an acceptable value.

Note: *If another value is not selected, the X-Cite 120 PC will automatically retain the value that was previously selected prior to the error message being displayed.*

13.4.5 Exposure Settings: Disabling Exposure Timer

To disable the exposure timer, *de-select* the checkbox next to “Exposure timer active”. This will allow the shutter to remain in the open or closed position as per the shutter control, without any set timing function.

13.4.6 Shutter Control

To activate the shutter control once the appropriate intensity and exposure settings have been entered, click on the “Open” button in the “Shutter Control” section.

Note: *During a timed exposure cycle, when the shutter is open, a red bullet will appear next to “Exposure”. Unit Status indicator will display Shutter “Open”.*

After the exposure cycle has been completed, the shutter will close and the exposure time will automatically reset. The Unit Status indicator will display Shutter “Close”. To close the shutter during an exposure cycle, click on the “Close” button.

13.4.7 Alarm Function

The following conditions will cause the unit to indicate an alarm condition:

- i) Lamp fail to strike
- ii) Lamp access door not correctly installed
- iii) Intelli-lamp sensor/ connection failure
- iv) Shutter position failure

The alarm condition is indicated by a repeating audible beep from the X-Cite® 120PC Q unit. The *Unit Status* indicator on the GUI will display *Alarm “On”*. To clear the alarm signal, click on the “Clear Alarm” button. The audible alarm on the unit will cease and the *Unit Status* indicator will display *Alarm “Off”*. In addition to clearing the alarm signal on the GUI, the X-Cite® 120PC Q unit must have the front panel power switch reset to clear the alarm condition. The fault which caused the original alarm condition must be corrected prior to resuming normal operation.

Note: *The “Unit Status” indicators on the GUI may be beneficial in diagnosing any potential causes relating to the alarm condition. Refer to Section 13 for additional information on troubleshooting.*

13.4.8 Accumulated Lamp Hours

The X-Cite® 120PC Q's accumulated lamp hours are indicated in the "Misc. Functions" section of the GUI. When the COM link for the unit has been established, the GUI will automatically update the unit's accumulated lamp hours. To update the accumulated lamp hours during remote operation, click on the "Get" button.

14 Messages / Indicators

The X-Cite® 120PC Q display and LED indicators provide information to the user to aid in unit operation and to advise when certain conditions exist. The following is a collective listing of messages and their meanings.

1. "XXXX."

A flashing decimal point to the right of the four numbers on the display advises the user that the unit is in Lamp Hour Mode. See [Section 11.1](#), Viewing the Accumulated Lamp Hours.

2. "XXX.X"

A decimal point to the left of the furthest right digit of the four digits on the display indicates the unit is in Timer Mode. The number shown will indicate the exposure time in seconds and tenth of seconds. See [Section 10](#), Timed Exposures.

3. " XXX "

Three digits on the display indicate unit is in Intensity Mode. The three digit number shown will indicate the percent iris opening. See [Section 10](#), Adjusting the Light Output.

4. "bulb"

The "bulb" message advises the user that the bulb has failed to ignite or extinguished after striking.

If the bulb message appears immediately and is accompanied by an audible beeping, this indicates that the lamp has not been installed correctly or that the wrong bulb type has been installed. See [Section 6](#), Installing the Lamp Module.

If the bulb message appears after about 25 seconds and is accompanied by an audible beeping, this indicates that the lamp has failed to strike. It may be a result of the lamp reaching end of life or that the lamp access cover is not secured properly in place. Press the START/STOP button to clear the audible alarm. Power down the unit, remove the lamp access panel and replace securely, tightening the fastening screw in place. Wait a few minutes and turn power on to the unit. If it still does not strike, replace the lamp.

5. " old / bulb"

The "old" and then "bulb" message appear in alternating sequence for about 10 seconds when power is first turned on to the unit if the accumulated lamp hours have exceeded 2500 hours. When this message occurs, it is recommended that the lamp be replaced soon.

6. "end / bulb"

The "end" and then "bulb" message appear in alternating sequence when power is first turned on to the unit if the accumulated lamp hours have exceeded 4000 hours. This indicates that the lamp has reached the end of safe life. If the lamp hours reach 4000 hours, safety measures will prevent the lamp from striking. The lamp must be replaced at this point.

7. "cool"

The "cool" message advises the user that the lamp must cool down before re-ignition. It appears on the display when power is turned on to the unit and the lamp is too hot to strike. Striking the lamp when it is too hot will reduce lamp life. The lamp will automatically strike once it has reached optimum temperature.

8. "LOC"

The LOC message appears for about 2 seconds when the UP/DOWN adjustments are initially locked. It also appears if the up or down button is pressed while they are locked, advising the user that these functions are locked out. See [Section 11.2– Locking and Unlocking the UP/DOWN Adjustment Buttons](#).

9. "ULOC"

The ULOC message appears for about 2 seconds after unlocking the UP/DOWN adjustment buttons to advise the user they have been unlocked. See [Section 11.2– Locking and Unlocking the UP/DOWN Adjustment Buttons](#).

10. "SFI"

The "SFI" message appears if there is a shutter failure. Power down the unit, wait a minute and turn power on to the unit. If the unit displays a shutter failure again, contact your local X-Cite Service Centre to have your unit serviced.

1. LAMP

The LAMP indicator is the top of two green LED's located to the left of the display. The LAMP LED illuminates when the lamp is on. The LAMP LED will flash when the lamp is warming up.

2. OPEN

The OPEN indicator is the bottom of two green LED's located to the left of the display. The OPEN LED illuminates when the shutter is open.

15 Clearing an Audible Alarm

15.1.1 The X-Cite® 120PC Q provides an audible alarm to alert the user of various error conditions. The following conditions will cause the unit to indicate an alarm condition:

- i) Lamp fail to strike
- ii) Lamp access door not correctly installed
- iii) Intelli-lamp sensor/ connection failure
- iv) Shutter position failure

15.1.2 To clear the audible alarm:

1. Press the START/STOP button

16 Troubleshooting

16.1 General



Service to be completed by qualified repair personnel only!

If the unit fails to power up, use the following checklist to eliminate the most common causes of problems. Check that:

1. The AC power cord is securely plugged into a functional AC wall plug.
2. The AC power cord is securely plugged into the AC inlet on the rear of the unit.
3. The mains AC power switch is in the ON position.
4. Check that the ventilation openings on both the bottom and rear of the unit are not blocked.



If the unit still does not power-up:

1. Check both mains power fuses by first disconnecting the power cord. Then carefully remove the fuse drawer assembly below the AC inlet on the rear of the unit. If the fuse(s) is/ are open, replace with the same type (4A, 250 V, Fast acting).



If the LED display lights and the fan starts, but the lamp won't turn on, check if:

1. The LED display indicates the “**bulb**” message and the system begins to beep. This indicates that no lamp has been detected. Check if the lamp has been installed correctly. Refer to [Section 4 – Installing the Lamp Module](#).
2. The LED display indicates the “**bulb**” message after a 20 or 30 sec. delay and the system begins to beep. This indicates that the lamp has failed to strike. It may be a result of the lamp reaching end of life or that the lamp access cover is not secured properly in place. Press the START/STOP button to clear the audible alarm. Power down the unit, remove the lamp access cover and replace securely, tightening the fastening screw in place. Wait a few minutes and turn power on to the unit. If it still does not strike, replace the lamp.
3. The LED display indicates the “**cool**” message. This indicates the lamp is too hot to strike. The lamp will automatically strike when it has cooled.
4. The LED display indicates alternately “**end**” then “**bulb**”. This indicates that the lamp has accumulated over 4000 hours and will not strike. The lamp module must be replaced.

If the light intensity is too low, check that:

1. The light guide has been fully inserted into the light guide retainer.
2. The X-Cite® 120PC Q unit includes an iris adjustment. Change the system to Intensity Mode and adjust the % of iris opening using the UP button to increase the illumination. See [section 9 – Adjusting the Light Output Intensity](#)
3. There are no foreign substances on the emitting end of the light guide.
4. There are no bends, kinks, or other physical damage to the light guide. Replace the light guide if there is any physical damage.
5. The LED display indicates alternately “**old**” then “**bulb**”. This indicates that the lamp has accumulated over 2000 hours and may require replacement.

It may be necessary to replace the lamp or the light guide. [Contact your sales representative](#) for information on purchasing a new lamp or light guide.

If the LED display indicates “SFI”:

1. This indicates there is a shutter failure.
2. Power down the unit wait 1 minute and turn the power back on.
3. If the unit once again displays the shutter failure message, [contact your local X-Cite Service Center.](#)

If the LED display does not light:

1. If the fan is functional, power down the unit, wait approximately 20 seconds then power it up again
2. If the problem persists, [contact your local X-Cite Service Center.](#)

If either Fan does not work properly

1. If the LED display is functional, power down the unit, wait approximately 20 seconds then power it up again
2. If the problem persists, [contact your local X-Cite Service Center.](#)

16.2 Liquid Light Guides

Proper handling and installation of liquid light guides

1. Liquid light guides have a typical useful life of 4000 hours of operation when handled properly and installed in a well maintained X-Cite 120. The formation of bubbles is one of the most common reasons for a light guide to degrade prematurely and result in a sudden reduction in illumination intensity. Bubbles can form without warning, and if they occur within the first 1500 to 2000 hours of use, is it typically due to overheating and/or mechanical stress to the light guide. Below are some simple tips to avoid overheating and stressing the light guide.
2. Always fully insert the light guide in to the X-Cite unit (i.e. up to the “A” line printed on the grey ferrule); this ensures contact with a heat sink to conduct heat away from the light guide.

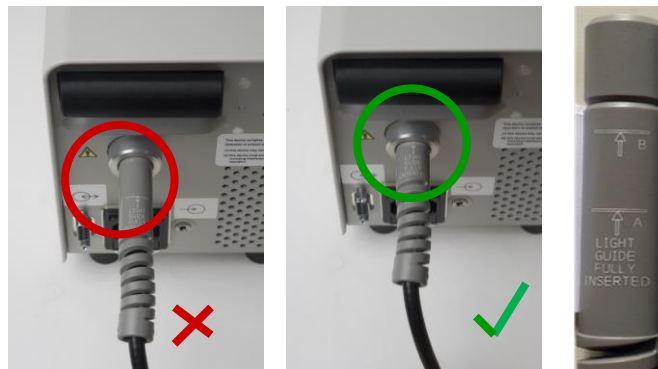

3. Always allow adequate clearance at the rear of the X-Cite unit and microscope to prevent excessive bending and/or crushing of the light guide against walls. Minimum bend radius to prevent immediate damage to the LLG is 40mm, however, a bend radius of at least 75mm is recommended for a light guide while "in use". Sharper bends can cause heat to build up and cause problems longer term.



4. Always place the X-Cite unit close enough to the microscope so that there is some slack in the light guide and no sharp bends.



5. Never leave an endcap on the output end of the light guide when the other end is connected to the X-Cite unit; if the unit is turned on in this condition, the cap will overheat, melt and/or permanently discolour the quartz end of the light guide.
6. Do not expose the light guide to extreme temperatures (above 35°C, below -5°C) for extended periods of time during use, transport or storage; this may cause degradation of the seals and allow air bubbles to form in the liquid.

What does a bubble look like?

Depending on the size and location in the light guide, a bubble may or may not be obvious. To check for bubbles:

1. Disconnect the LLG from the X-Cite and microscope adapter.
2. Hold one end towards a bright window or overhead room light - DO NOT use an X-Cite or any other focused light source for this test!

3. Look at the quartz at the other end of the LLG
 - a. Bubble-free: quartz end will appear as a bright, solid circle; you may also be able to see a thin circular outline at the quartz/liquid interface.
 - b. Bubbles at/near the quartz end: appear as dark spots, as small as 0.5mm in diameter or even as larger more defined spheres.
 - c. Bubbles in the middle of the light guide: may not be well-defined spots, but will appear as dark shadows
 - d. In extreme cases, where the bubble is blocking the entire diameter of the light guide, no light will come through, even when pointing the distal end at a light source.

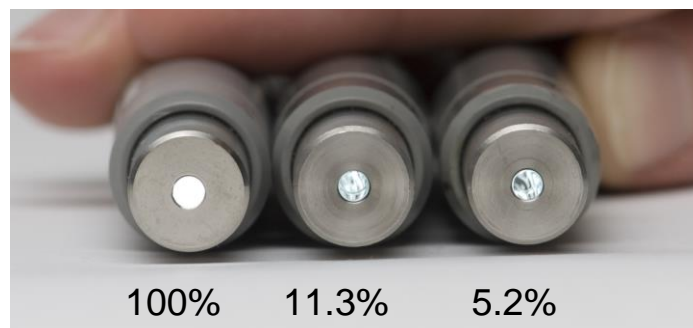

- e. Appearance and % output of light guides with bubbles relative to an LLG without bubbles (100%).

Can a bubbled light guide recover?

1. Yes, light guides with small bubbles can sometimes recover. Disconnect the light guide from the X-Cite unit, and leave the light guide undisturbed on a shelf for 1-2 weeks. For this to be effective, it is important to catch the bubble when it is small.

When should light guides be replaced?

1. It is usually time to replace a light guide when:
 - Illumination is low and replacing the lamp does not improve brightness
 - Dark or uneven areas become visible in the field of view (a bubble is blocking part of the light)
 - A section of the light guide becomes noticeably warmer than the rest of the guide (a bubble is blocking transmission of light, forcing the light guide to absorb the energy)
 - It is 2-3 years old OR has been in use for 4000-6000 hours (2-3 lamp changes)

16.3 Lamps

Performance and lifetime

1. The lamp output spectra and typical output levels over lifetime are shown below.

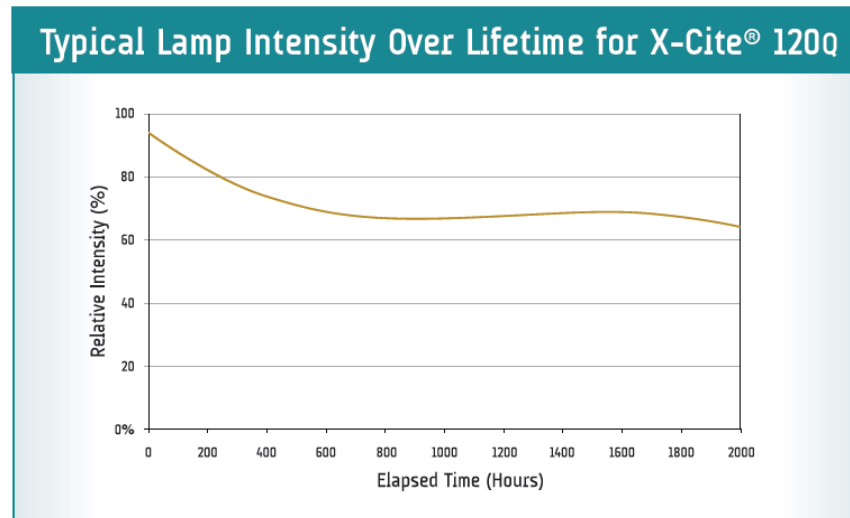
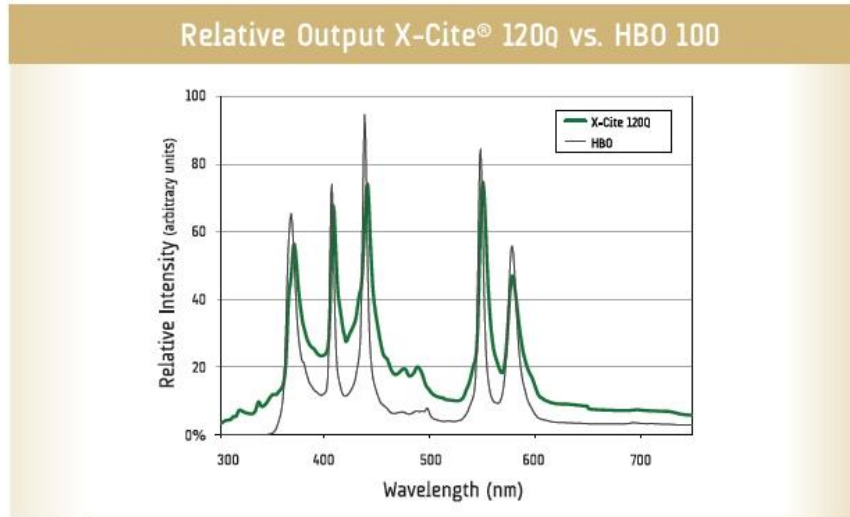

2. It is normal for the output to decline over the first several hundred hours of use and then stabilize at a level ~70% of the initial output for the remainder of the lamp life. If the lower power regions of the output spectra are being used, it may be desirable to replace lamps more frequently to maximize signal levels.

16.4 Air Vents & Filters

X-Cite units have several air vents that are an integral part of the cooling system and overall lamp performance. Proper cooling ensures that lamps operate at optimal temperature and pressure for output power, spectrum, lamp life, light guide life and safety.

Ensuring adequate cooling

1. Never obstruct the air vents on the X-Cite unit. Vents are located at the rear and underside of the unit. (Note: Arrows indicate direction/location of air flow. In earlier X-Cite models vents were located on the side, underneath the lamp access panel.)



2. Always leave clearance for air flow between the X-Cite and walls or other equipment. Do not remove the rubber feet on the X-Cite unit or otherwise reduce/block the space between the bottom of the unit and bench top. This may compromise airflow through the unit.

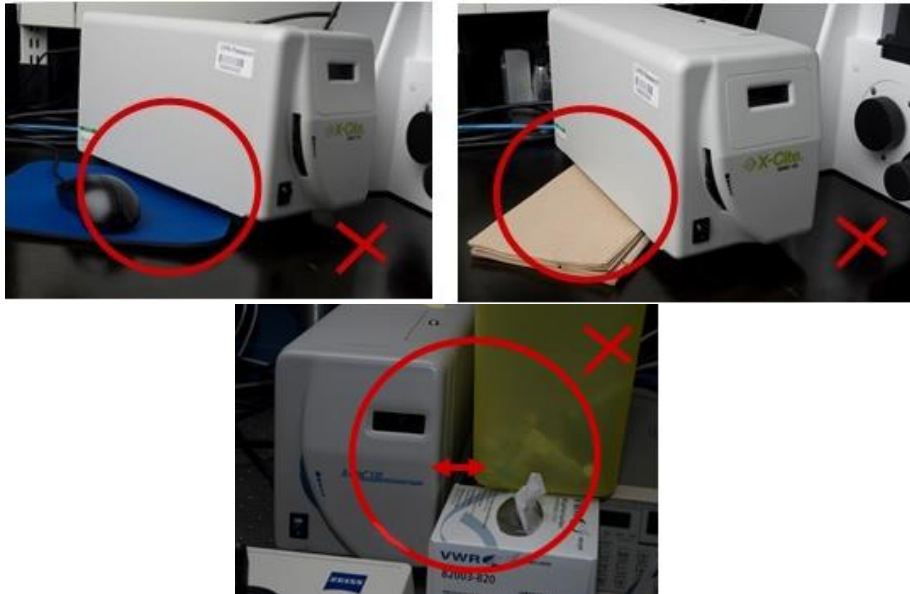

3. Ensure that the air being used to ventilate the X-Cite unit is approximately “room temperature” (e.g. do not place the X-Cite unit on top of another heat-producing instrument).
4. If a heated environmental chamber is being used for live cell imaging, make sure that the X-Cite unit and the light guide are located outside of the chamber.
5. Periodically check the air filter at the air intake vent for debris. Replace or clean as necessary.

How to check/clean X-Cite® 120PC Q metal vents

1. When unit is OFF and lamp is COOL, unplug power from X-Cite unit and turn unit upside down. Visually inspect the metal gratings for lint, dust and other debris.
2. Debris can be removed from the gratings using a small vacuum cleaner with a crevice tool, or blown out with a can of compressed air. If using compressed air, direct the air flow ACROSS the vents, not perpendicularly (i.e. into the X-Cite unit).

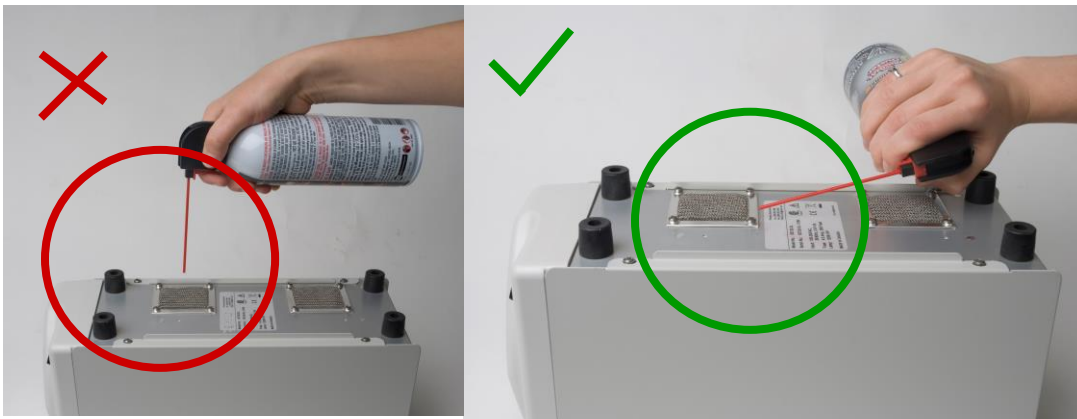

What happens if filters are not clean?

1. A complete filter blockage or airflow obstruction generally results in an automatic lamp shutoff within 10-15 minutes of the unit being powered on due to lack of adequate cooling.
2. A partially clogged filter may allow enough airflow for continued operation, but not for optimal cooling. In this case, the result is usually dramatically reduced lamp life, e.g. 400 hours instead of 2500+ hours.

17 Routine Care and Maintenance

1. Operate the unit in a well ventilated area with at least six inches clearance at the rear of the unit for proper air flow. Do not place any objects below the unit or between the feet as this will restrict airflow through the bottom of the front face plate.
2. For safe operation, use only a grounded outlet.
3. Avoid physical shocks or jarring to the unit especially while the unit is operating. Such sudden movements reduce the lamp module life.
4. The lamp module must be operated for a minimum of 20 minutes each time it is turned on to prevent damaging the lamp. Increasing the time between turning the lamp module on and off will maximize lamp life.
5. Replace the air filters frequently to ensure unrestricted air flow. It is recommended as a minimum that the air filter be removed and washed with a mild detergent and water every time the lamp module is replaced.

Note: *restricted airflow can cause the lamp temperature to increase above optimum temperature, significantly reducing lamp life.*

6. When necessary, clean the light emitting end of the light guide using an optical cleaning solution.
7. Cleaning of unit is not required, however if cleaning is desired, disconnect the AC power cord from the unit and use only a water and simple detergent solution. Ensure that cleaning solution does not come in contact with any optical, moving mechanical or electrical parts.
8. Recommended operation of the X-Cite 120 is in horizontal position using the X-Cite 120 beyond 15% of tilt from a horizontal position will wear lamp life.

17.1 General tips to help maximize lamp lifetime:

1. Each time the lamp is ignited, the stress on the lamp effectively decreases lamp life by 5 hours, therefore it is recommended to avoid shutting down the unit during lunch or short breaks or between users, if being used in a multi-user lab.
2. After lamp ignition, avoid turning the lamp off until it has run for a minimum of 20 minutes.
3. Avoid attempting to strike a hot lamp (note: the X-Cites' Intelli-Lamp will prevent this).
4. Avoid unnecessary movement and jarring of the lamp, especially when it is in operation or hot.
5. When changing a lamp:
 - a) Handle the lamp only by the ceramic areas.
 - b) Never touch the glass envelope of the bulb (inner stem), the inner surface, or the outer surface of the reflector. If touched, carefully clean the envelope with alcohol. Skin oils can etch the glass and cause premature bulb failure.
 - c) Wear cotton gloves or powder free latex gloves when handling any lamp.
6. Ensure that air filters are kept clear of dust and debris – even a partially blocked filter can reduce lamp lifetime to approximately 25% of what is normally expected.

18 Technical Specifications

18.1 Lamp module

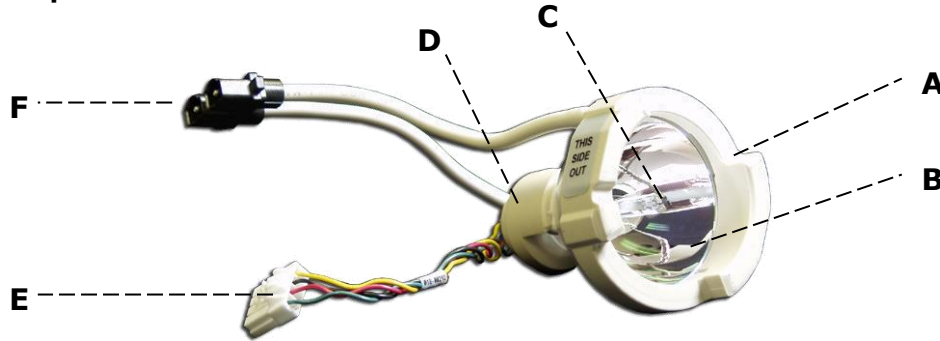

A, D: Ceramic Components. **B:** Reflector. **C:** Bulb.
E: Intelli-Lamp Connector. **F:** Lamp Power Connector

Lamp Module	High Pressure 120 watt mercury vapor short arc
Lamp Module Life	2000 hours (typical)
Warm Up	90 seconds (typical)

18.2 Light Guide

Light Delivery

Flexible liquid filled light guide 1.5m or 3m in length with a core diameter of 3mm. Custom light guides are also available.

Liquid Light Guide End Fitting

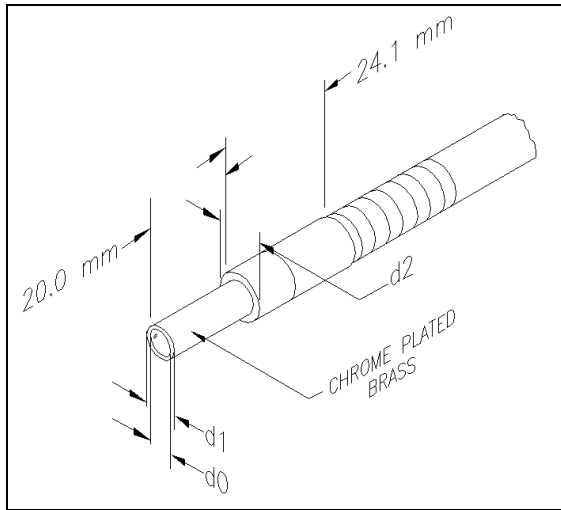

Liquid Light Guide Dimensions in mm

Core	End Fitting	End Fitting Radius	Minimum Bend (mm)
d0	d1	d2	
3	5	9	40

18.3 Power Input

Power Supply:	High efficiency, switch mode, constant power output
Input Voltage:	100-240 V, 50/60Hz
Current:	2.4 – 1.0A (100-240V)
Input Surge:	50A max. (cold start)
Protection:	Short circuit auto-recovery Over voltage (up to 135%, +/- 5% of nominal) EMI filtering integrated into the PFC module Lamp driver circuit has integrated thermal cut-off
Fuse Rating:	Dual fuse system: each fuse rated at F4A 250V (Fast acting type)

18.4 Lamp Power (electrical)

Lamp Voltage:	85V RMS, square wave, 50% duty cycle, 1.4A typical
Output Power:	Lamp: nominal 120W
Max. Lamp Voltage:	115V RMS
Lamp Drive Frequency:	150 Hz
Line Regulation:	From min Vin to max Vin lamp: +/-2%

18.5 Environmental Operating Conditions

Operating Temperature:	5 to 40° C max.
Altitude:	2000m max.
Humidity:	15 to 90% RH (non-condensing)
Atmospheric Pressure:	70 to 106 kPa
Over voltage Category:	II
Pollution Degree:	2

18.6 Transport and Storage Conditions

Temperature:	-40 to 70 degrees Celsius
Relative Humidity:	10% to 95% RH (non-condensing)
Atmospheric Pressure:	500 to 1060 kPa

18.7 Regulatory Compliance

Product Safety and Electromagnetic Compatibility

The X-Cite 120PC Q has been tested and found to comply with product safety and electromagnetic compatibility requirements. For a complete list of tests and for certification details, please contact your X-Cite representative or visit <http://www.excelitas.com/Pages/Product/X-Cite-120PC-Q.aspx>.

CE Marking

Council Directive 2014/35/EU
Council Directive 2014/30/EU
Council Directive 2012/19/EU
Council Directive 2011/65/EU

Low Voltage Directive
EMC Directive
WEEE Directive
RoHS



FCC Part 15, Subpart B, Class A Digital Device or Peripheral – Information to User

NOTE: *This equipment has been tested and found to comply with the limits for a Class A digital device, pursuant to Part 15 of the FCC Rules. These limits are designed to provide reasonable protection against harmful interference when the equipment is operated in a commercial environment. This equipment generates, uses, and can radiate radio frequency energy and, if not installed and used in accordance with the instruction manual, may cause harmful interference to radio communications.*

Operation of this equipment in a residential area is likely to cause harmful interference in which case the user will be required to correct the interference at his own expense.

Warning: *Changes or modifications not expressly approved by Excelitas Technologies could void the user's authority to operate the equipment.*

WEEE Directive (2012/19/EU)



The symbol above indicates that this product should not be disposed of along with municipal waste, that the product should be collected separately, and that a separate collection system exists for all products that contain this symbol within member states of the European Union.

- The equipment that you bought has required the extraction and use of natural resources for its production. It may contain hazardous substances that could impact health and the environment.

- In order to avoid the dissemination of those substances in our environment and to diminish the pressure on the natural resources, we encourage you to use the appropriate take-back systems. Those systems will reuse or recycle most of the materials of your end life equipment in a sound way.
- The crossed-out wheeled bin symbol indicated above invites you to use those systems.
- If you need more information on the collection, reuse and recycling systems, please contact your local or regional waste administration.

18.8 China RoHS



The symbol above indicates that this product is in compliance with China RoHS requirements.

19 Warranty

Excelitas Technologies warrants the original purchaser for a period of one (1) full year, calculated from the date of purchase, that the equipment sold is free from defects in material and workmanship.

In the event of a claim under this guarantee, the equipment is to be sent postage and carriage paid, including a description of the fault, to the Excelitas Technologies Service Center. Returned equipment will not be received without a Return Authorization (RA) Number, issued by the appropriate Service Center.

In the case of damage caused by wear and tear, careless handling, neglect, by the use of force or in the case of interventions and repairs not carried out by an Excelitas Technologies Service Center, the guarantee ceases to be valid. This guarantee may not form the basis for any claims for damages, in particular not for compensation of consequential damages.

The warranty is not transferable. No warranty is extended to perishable items, such as fuses, air filters and light guides. Any claims for units received with defects in material or workmanship must be reported to an authorized Excelitas Technologies Service Center within 30 days from the original date of receipt.

Replacement Bulb Warranty

If the X-Cite® 120PC Q bulb fails to strike during the warranty period of 2000 hours, the bulb will be replaced under warranty, or a credit will be applied to the purchaser's account. In the event of a claim under this guarantee, the lamp is to be sent postage and carriage paid, including a description of the fault, to the Excelitas Technologies Service Center. Returned equipment will not be received without a Return Authorization (RA) Number, issued by the appropriate Service Center. Lamps must be purchased from an authorized Excelitas Technologies Representative or Distributor to be eligible for the warranty replacement. This warranty is non-transferable.

In the case of damage caused by careless handling, neglect, by the use of force or in the case of interventions and repairs not carried out by an Excelitas Technologies Service Center to the X-Cite® 120 system, the guarantee ceases to be valid.

Returning equipment to Excelitas Technologies

1. Please make a note of the problem encountered, the steps followed to isolate the problem and the result of any trouble shooting steps taken.
2. Contact the nearest Excelitas Technologies Service Centre to obtain a Return Authorization Number. For your convenience, RA numbers can also be requested on-line at: <http://www.excelitas.com/Pages/Support/Service-Request-Form.aspx>
3. Follow shipping instructions provided by the service technician. The unit should be returned in its original packaging if possible. Please do not ship the unit with the lamp installed.

20 Contact Information

Excelitas Canada Inc,
Tel: (905) 821-2600
Fax: (905) 821-2055
1-800-668-8752 (*USA and Canada*)
x-cite@excelitas.com
<http://www.excelitas.com/Pages/Product/X-Cite.aspx>

20.1 Service Centers

For a complete list of authorized service centers please visit:
<http://www.excelitas.com/Pages/Support/Service-Centers.aspx>

20.2 Replacement Parts

Replacement lamps and light guides can be purchased directly from Excelitas Technologies. For ordering and pricing information contact the inside sales department at:

x-cite@excelitas.com
<http://www.excelitas.com/Pages/Contact/Contact-Us.aspx>
1-800-668-8752

Part Number	Description
012-63000	X-Cite 120 lamp module
Collimating Adapter – call to match microscope	
805-00038	X-Cite 120 Light guide (3mm x 1.5m)
805-00040	X-Cite 120 Light guide (3mm x 3.0m)
Grounded power cord (IEC) – call to match AC voltage	
850-00023R	Hex Key, 3mm (Lamp access cover)
035-00329R	X-Cite® 120PC Q English Quick Start